

Durable and high-quality stone construction

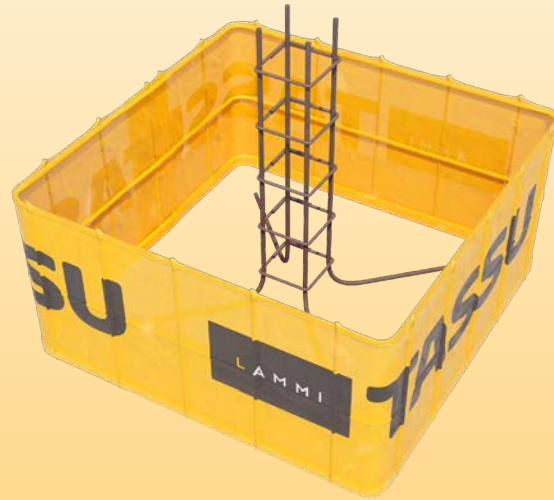

LAMMI

The highest quality
concrete blocks in
the market.

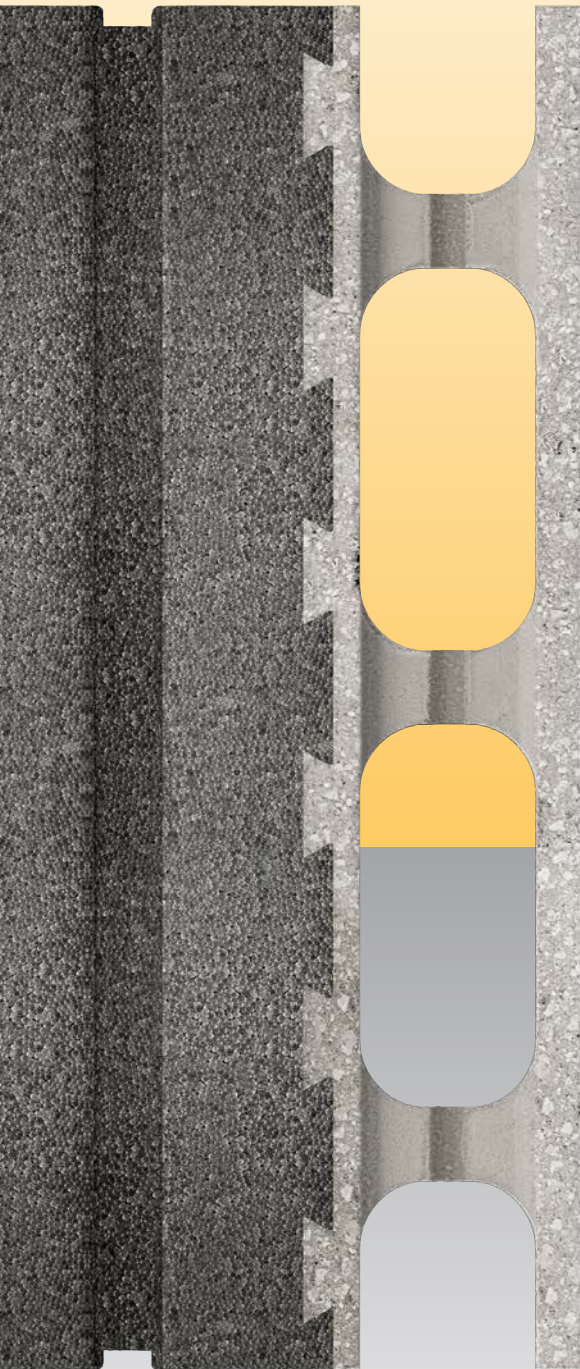

With Lammi hollow concrete blocks, work is easy and quick. The result of long product development, Lammi hollow concrete blocks are dimensionally accurate, fire safe, undecaying and weather- and frost-resistant.

A designers' favourite

Lammi hollow concrete blocks are suitable for building foundations, cellars and wall structures. A massive, compact wall structure ensures excellent energy efficiency and effective sound isolation. With Lammi hollow concrete blocks, you achieve an excellent loadbearing capacity and strength. The blocks make it possible for reinforcement to be positioned so that the protective concrete layer in the structure is in line with concrete standards. This way, the service life of the structure can be ensured already in the design stage. Our range includes pre-designed product families that make construction easy, such as corner blocks, end blocks and partial blocks, and the patented lintel block system.

On our website, you can find tools to facilitate design, and we are also glad to help you by telephone.

Makes building easier

Installing pipework, cabling and wall sockets into walls is easy thanks to concrete cavities. As a coating base, the surface of a concrete block is optimal in both interior and exterior walls. Furniture and interior design elements do not need separate supports or special brackets; they can be mounted directly to the stone wall. Lammi hollow concrete blocks are diamond-ground to a specified vertical dimension. This is the most important quality of dry-laid masonry blocks in terms of the erection of a structure.

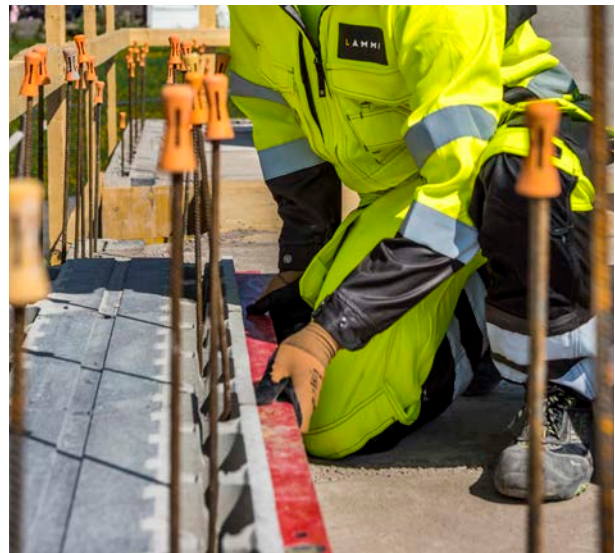
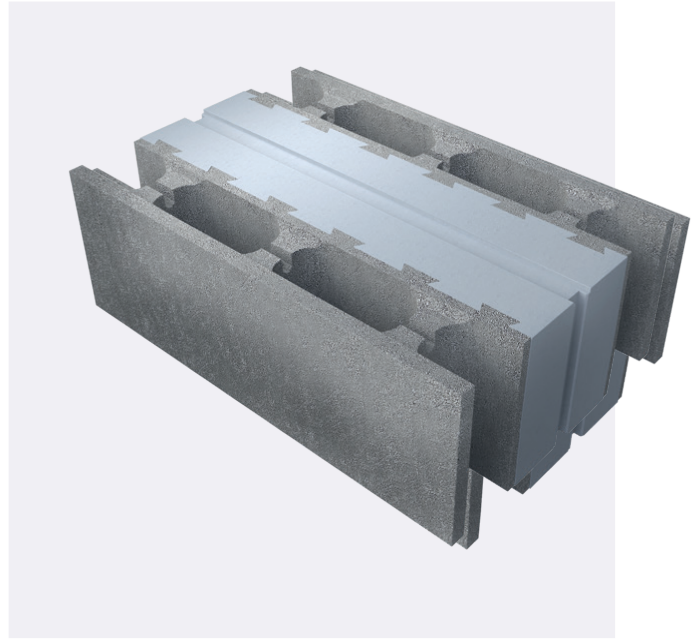

Safe choice

The production of Lammin Betoni is certified by **Building Information Foundation RTS Finland**. Lammi hollow concrete blocks are safe and high-quality products that meet the requirements of the best M1 class of the interior climate classification. Manufactured of Finnish natural stone, Lammi hollow concrete blocks are completely recyclable, including the graphite EPS insulation. With Lammi hollow concrete blocks, you can build a massive, healthy and safe wall structure for all kinds of buildings.

Lammi insulated hollow blocks®

- U-value 0,11W/m²K, thermal stone 500
- U-value 0,17W/m²K, thermal stone 400
- U-value 0,25W/m²K, thermal stone 350
- Sound insulation (coated wall) 51 dBA (R_w)
- Wall weight, cement-bound 550kg/m²
- Stone consumption 8,33 kpl/m²
- Concrete consumption
 - LL500: 133 l/m²
 - LL400: 133 l/m²
 - EMH350: 125 l/m²

The package sizes of the products can be found on our website.

Measurements: length x width x height

Thermal block 400
600 x 400 x 200 mm
27 kg

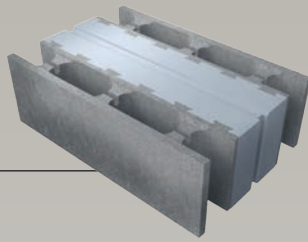

Thermal block 350
600 x 350 x 200 mm
29 kg

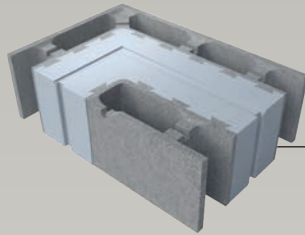
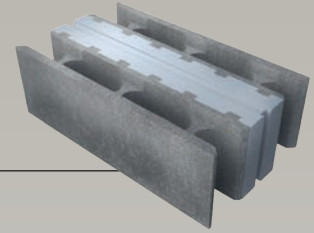

Thermal block 400 corner
600 x 400 x 200 mm
28 kg

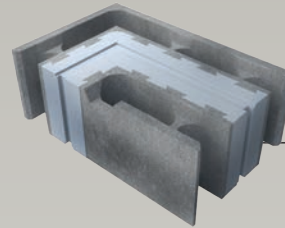

Thermal block 350 corner
550 x 350 x 200 mm
29 kg

Thermal block 400 end
600 x 400 x 200 mm
26 kg

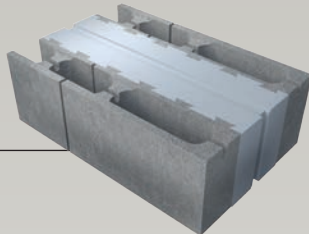

Thermal block 350 end
600 x 350 x 200 mm
29 kg

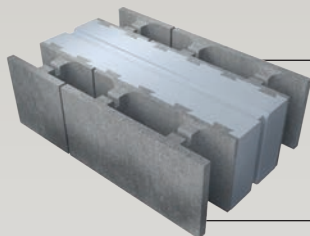
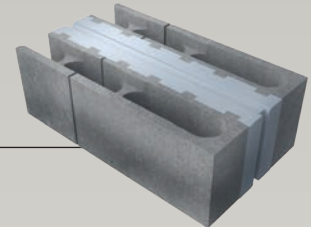

Thermal block 400 1/3 partial
200 x 400 x 200 mm
9 kg

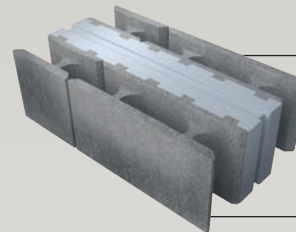

Thermal block 350 1/3 partial
200 x 350 x 200 mm
10 kg

Thermal block 400 2/3 partial
400 x 400 x 200 mm
17 kg

Thermal block 350 2/3 partial
400 x 350 x 200 mm
18 kg

Pre-cut partial blocks and end blocks are sold and delivered as an entity.
Blocks are cut at the worksite by sawing the insulation with a hand saw.

Steel lintel
AT70
6000 x 70 x 40 mm

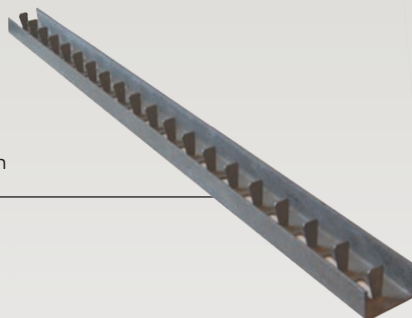

Split block
600 x 175 x 200 mm
15 kg

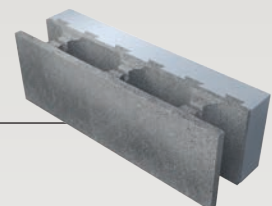

The handedness of the corner blocks can be changed by turning the blocks.
The package sizes of the products can be found on our website.

LL500-insulated hollow block – new type of energy efficiency

The thermal insulation capacity of LL500 is the best in the market (U value 0.11). In a well-designed stone house, it can be used to achieve very low energy consumption. With careful design, matching structures and the LL500 insulated hollow block, it is possible to achieve excellent building-envelope heat insulation and air tightness. Improved energy efficiency serves both nature and people: emissions are reduced, heating costs decrease and living comfort increases.

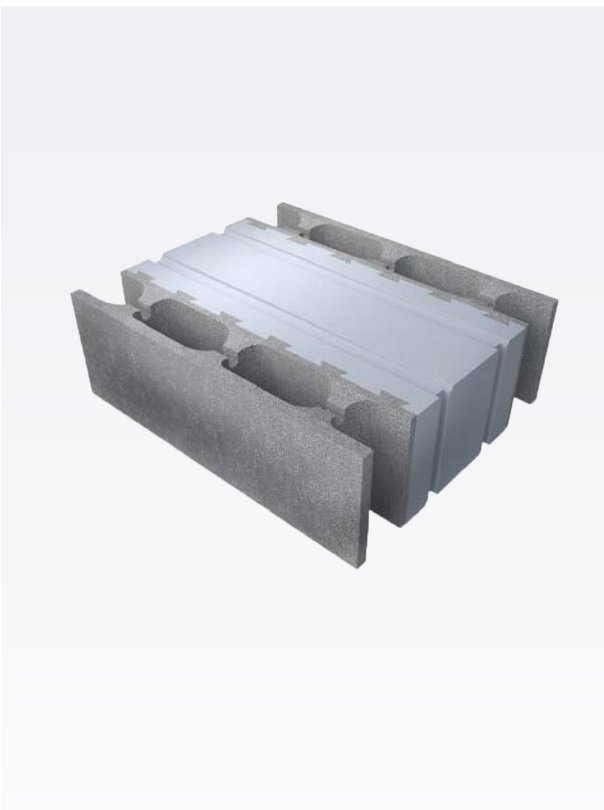
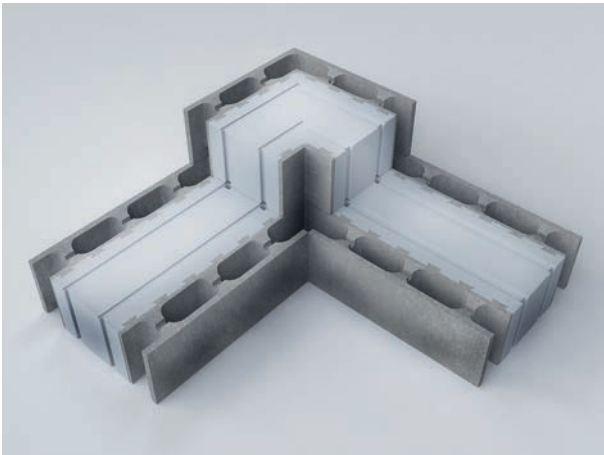

Indoor air quality and living comfort

A basic requirement for the energy-efficient implementation of a safe, healthy and comfortable indoor environment is an airtight building envelope that functions correctly from the structural physical point of view. It also minimises the heating and cooling needs of the building during different seasons. Minor air infiltration routes, uniform temperature and good and controlled ventilation make good indoor air, high energy efficiency and living comfort possible.

Blocks does not decay or mould, because it features no organic materials. The structure of Lammi insulated hollow concrete blocks makes faultless building easy and secures the air quality of your house against problems inside walls. Stone is the most reliable building material in terms of moisture performance. Therefore, it is also recommended to be used in wooden houses, at least for wet room walls, cellars and foundations.

Massive and warm

Suitable for exterior walls of detached houses, terraced houses and blocks of flats, thermal blocks are always a great choice when you want to invest in the strength, tightness, massiveness and thermal insulation capacity of a wall. Lammi's 500 mm and 400 mm wide insulated hollow blocks are intended for high-quality low energy construction.

The effective thermal insulation and heat accumulation capacity and the absolute tightness of the cast structure guarantee excellent heat economy of external walls. The thermal block is also available as a 350 mm wide option suitable for walls and foundations of half-warm spaces, for example.

Dry-laid thermal blocks make construction easy and quick. The top edge of the blocks is diamond ground to a specified dimension. This makes even high structures easy to build.



Easy and quick building

Insulated hollow blocks are not bedded in; they are just dry-laid. At the same time, the structure is reinforced and the seams of the thermal insulation are sealed with urethane foam. After dry laying, the cavities of the structure are filled with fresh concrete. This creates a strong structure of exceptional tightness and massiveness.

Graphite EPS – eco-efficient insulating material

The energy efficiency of Lammi insulated hollow block is achieved by using eco-efficient graphite EPS insulation. Its excellent insulation capacity is based on the graphite included in it, thanks to which a large part of the infrared, i.e. thermal, radiation is reflected back and does not penetrate the wall. The thermal insulation of graphite EPS is 20% better than an equal EPS without graphite particles. Therefore, to reach the same thermal insulation, the thickness of the insulation can be reduced compared to traditional EPS. The amount of raw material used can be decreased in proportion to reduce the environmental effect of the product.

Measurements: length x width x height

Thermal block 500
600 x 500 x 200 mm
29 kg

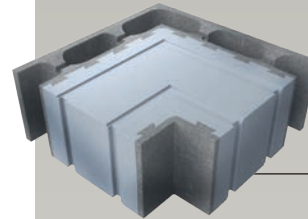
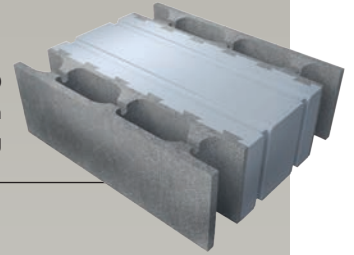

Thermal block 500 corner
500 x 500 x 200 mm
24 kg

Thermal block 500 end
600 x 500 x 200 mm
29 kg

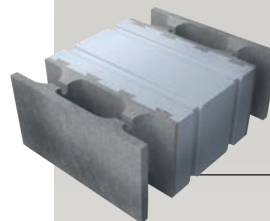
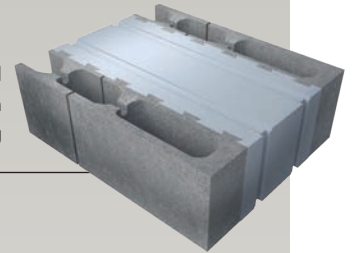

Thermal block 500, 400 mm partial
400 x 500 x 200 mm
19 kg

Thermal block 500
Module alignment block
300/300 x 500 x 200 mm
29 kg

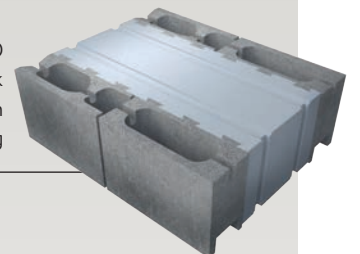

The measurement system of the blocks has been designed for 2M modular coordination. We also offer the pre-cut 300/300 module alignment block enabling 1M horizontal module coordination for LL500.

Lammi partition wall blocks®

- Sound insulation (coated wall) 38 dB (R_w)
- Stone consumption 8,7 kpl/m²
- Adhesive mortar consumption appr. 2kg/m²
- Concrete consumption 45 l/m²
- Wall weight 112 kg/m² without concrete pouring

The package sizes of the products can be found on our website.

The dimensionally accurate partition wall block is suitable for light partition walls of both wooden and stone buildings. The block is easy to process, and since half blocks are also available, the need to cut the blocks is minimal. The partition wall blocks are mounted with thin joint mortar.

Smooth indoor work phases

The partition wall block features generous cavities for easy installation of cables, wall sockets, water pipes and tap angle boxes. This helps to avoid laborious grooving and inaeesthetic surface installation. A sound-insulating incombustible stone wall that can withstand mountings and moisture is also an ideal base for different coatings.

Entire partition stone system

The partition concrete blocks can be used to create a quality 100 mm thick partition wall. If necessary, the wall can be reinforced locally with concrete pouring. This way, the mounting of heavy loads, for example, can be safely performed. With diamond ground, dimensionally accurate block, adhesive bonding is easy and quick. The correct frame height can be reached with whole blocks. The partition wall block system also includes zinc coated steel lintels. This facilitates and quickens the installation work, because openings do not need to be separately supported.

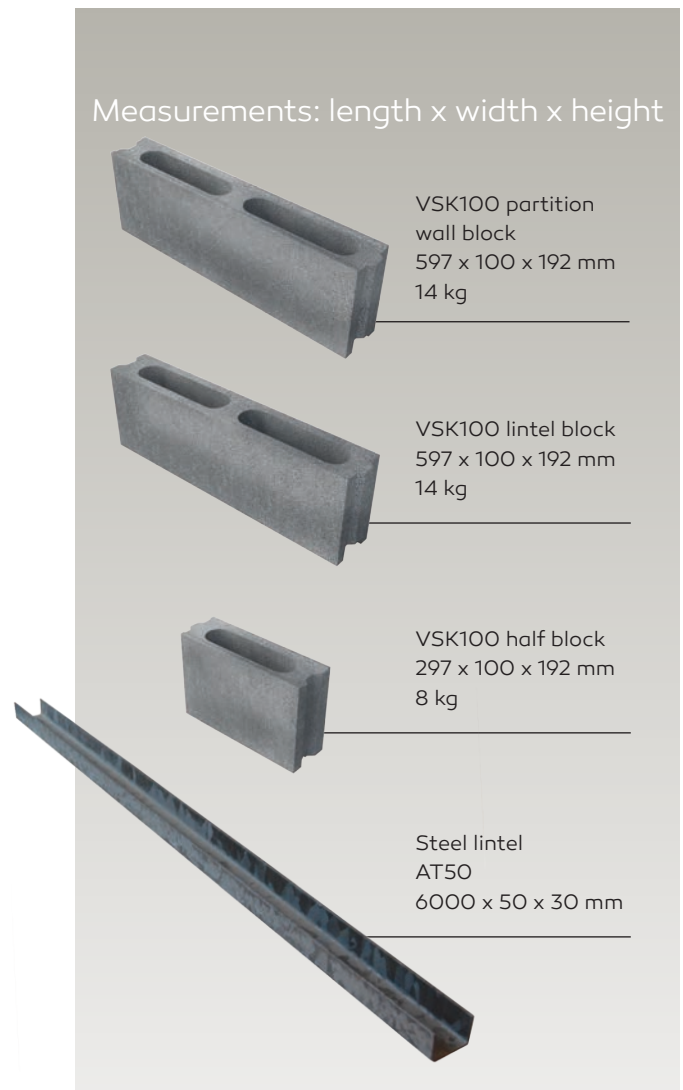

Easily and quickly laid hollow concrete block

Lammi was the first to launch the castable hollow concrete blocks in the early 1970s. In the last few decades, concrete block products have developed and a huge amount of experience has been gained of using them. Lammi hollow concrete blocks are a safe choice for today's demanding builders.



Carefully considered details

The vertical measurement of the hollow concrete blocks has been diamond ground to a specified dimension. Thanks to this, even high structures are easy and quick to install. Ready-made end blocks and corner blocks also make the work easier. In concrete block structures, the thickness of the protective concrete layer of the reinforcement can always be made sufficient. Reinforced concrete blocks create a massive, tight and strong structure suitable for different kinds of construction. Before casting, the necessary technology can be installed inside the hollow concrete block structure. This way, the laborious grooving of the wall can be entirely avoided.

Versatile applications

Thanks to the simple technique, the concrete block is suitable for both professionals and DIY builders. The blocks are particularly suitable for foundations, soil pressure walls and loadbearing compartment walls. Supporting walls, earth cellars and especially structures in tight spaces, such as lift shafts, silo structures and renovation targets, are also ideal for building with concrete blocks. The tongued and grooved ends help the blocks support each other. A strong, tight and seamless concrete block wall is an optimal coating base for all coatings.

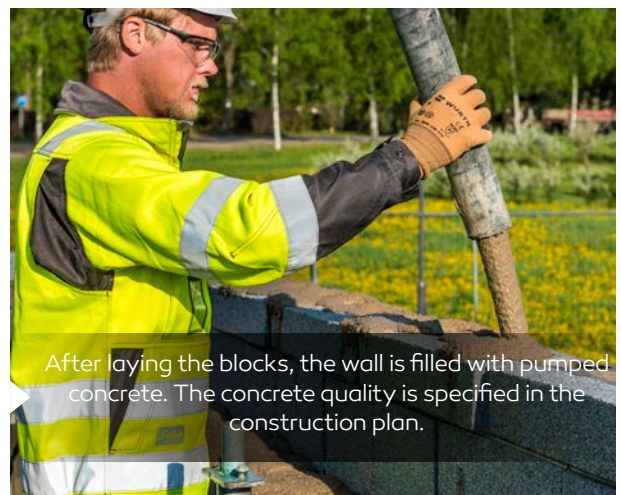

After laying the blocks, the wall is filled with pumped concrete. The concrete quality is specified in the construction plan.

Measurements: length x width x height

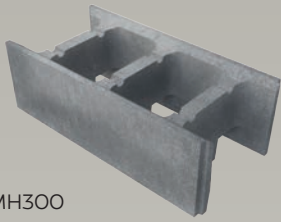

MH300
600 x 300 x 200 mm
27 kg
Concrete consumption 210 l/m²
Wall weight, cement-bound 715 kg/m²
Sound insulation 65 dBA (R_w)

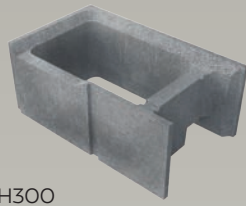

MH300
corner block
500 x 300 x 200 mm
22 kg



MH300
end block
600 x 300 x 200 mm
28 kg



MH300
end block
400 x 300 x 200 mm
19 kg

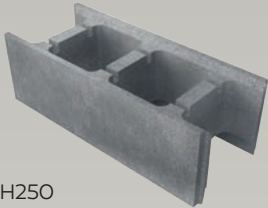

MH250
600 x 250 x 200 mm
25 kg
Concrete consumption 150 l/m²
Wall weight, cement-bound 550 kg/m²
Sound insulation 64 dBA (R_w)

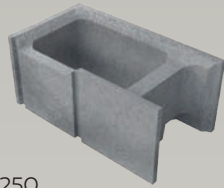

MH250
corner block
450 x 250 x 200 mm
17 kg

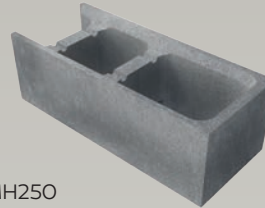

MH250
end block
600 x 250 x 200 mm
25 kg

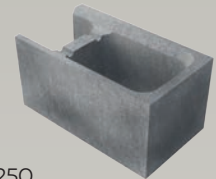

MH250
end block
400 x 250 x 200 mm
17 kg

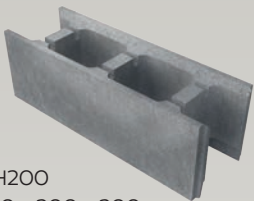

MH200
600 x 200 x 200 mm
21 kg
Concrete consumption 115 l/m²
Wall weight, cement-bound 450 kg/m²
Sound insulation 62 dBA (R_w)

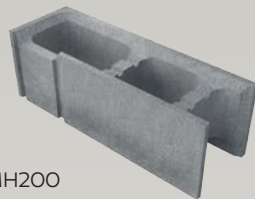

MH200
corner block
600 x 200 x 200 mm
21 kg

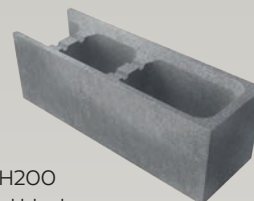

MH200
end block
600 x 200 x 200 mm
22 kg

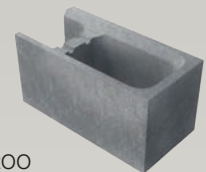

MH200
end block
400 x 200 x 200 mm
15 kg

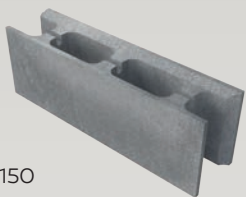

MH150
600 x 150 x 200 mm
20 kg
Concrete consumption 80 l/m²
Wall weight, cement-bound 350 kg/m²
Sound insulation 58 dBA (R_w)

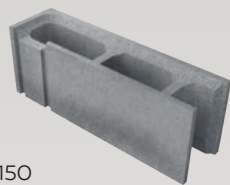

MH150
corner block
550 x 150 x 200 mm
17 kg

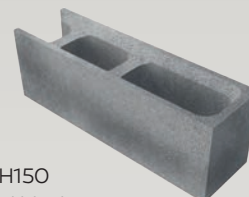

MH150
end block
600 x 150 x 200 mm
19 kg

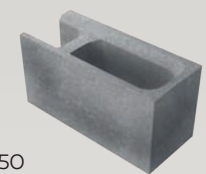

MH150
end block
400 x 150 x 200 mm
13 kg



PH250
column block
250 x 250 x 200 mm
Consumption 5 kpl/m
14 kg
Concrete consumption 36 l/jm

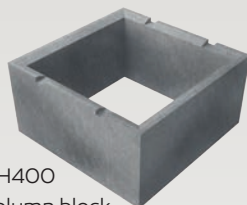

PH400
column block
400 x 400 x 200 mm
Consumption 5 kpl/m
26 kg
Concrete consumption 110 l/jm



PPH300
column block
Ø 300 x kork. 200 mm
Consumption 5 kpl/m
13 kg
Concrete consumption 45 l/jm

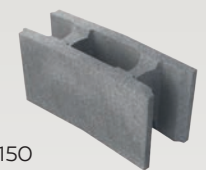

KMH150
curved block
400 x 150 x 200 mm
Consumption 12,5 kpl/m²
12 kg
Concrete consumption 80 l/m²
Suitable for 3-7 m diameters
Wall weight, cement-bound 350 kg/m²
Sound insulation 58 dBA (R_w)

Stone consumption 8,33 kpl/m² (600 mm), unless mentioned otherwise.
The package sizes of the products can be found on our website. The end blocks and corner blocks are sold in pairs.

Lammi KK400 insulated hollow block – the result of long-term product development is here



The Lammi KK400 thermal casing block has been designed to meet the needs and wishes of professionals. The new insulation block was created because we wanted to improve the properties and control of the plaster base and surface. Our final product provides an interesting alternative for block construction: it simplifies and speeds up the construction process and enhances the strength and service life of the structure and plaster surface.

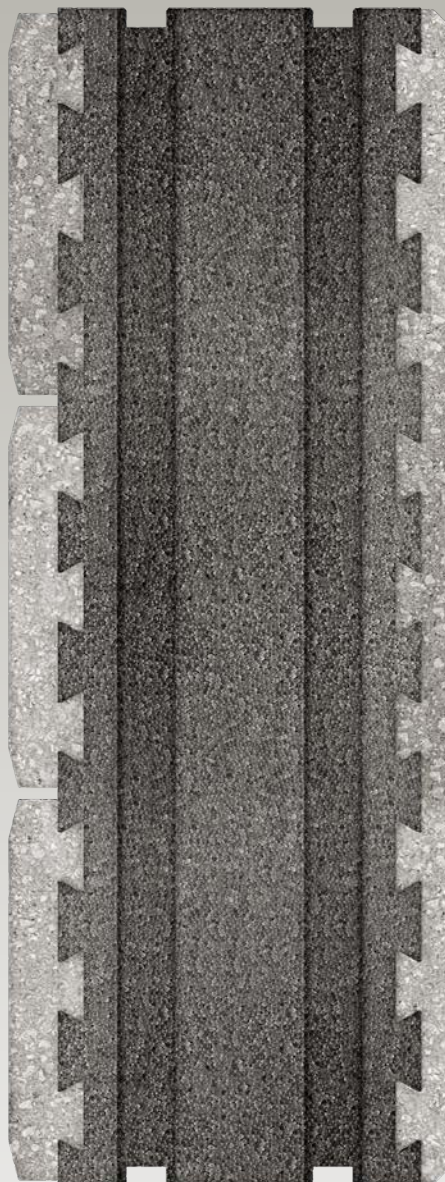

▶ Facade can be plastered immediately after casting

▶ Quick and easy to cast

▶ Facade has good impact resistance

▶ Excellent load-bearing capacity and fire resistance

▶ Great sound insulation

U-value: 0,17W/m²K. Concrete consumption: 120 l/ m². Stone consumption: 8,33 kpl/ m²
Weight of the finished wall: 525 kg/m². Sound insulation, R_w: 56. Fire rating: A1

Effortless construction with state-of-the-art features



The excellence of the Lammi KK400 thermal casing block is based on its innovative outer casing structure. A registered concrete casing, 25 mm thick and divided into 200 x 200 mm squares, serves as the outer casing and plaster base. The casing has fantastic impact resistance and is ready for plastering immediately after casting.

The load-bearing inner casing of the thermal casing block consists of 200 mm concrete casing; graphite EPS is used as insulation. A composite profile patented by Lammi is used for lintel blocks.

The thermal casing block is quick to build and easy to cast due to a single side with a cast hole. Construction is faster thanks to a hard concrete casing that can be plastered instantly. Besides fantastic impact resistance, the thermal casing block has excellent load-bearing, loading and soil pressure capacities. The Lammi KK400 thermal casing block is superbly suited for technically challenging structures with high strength requirements, such as blocks of flats, industrial buildings and elevated subterranean structures.

Besides these features, an excellent fire rating, sound insulation and preservability ensure that the thermal casing block is a safe and durable choice.

Measurements: length x width x height

KK400
600 x 400 x 200 mm
27 kg

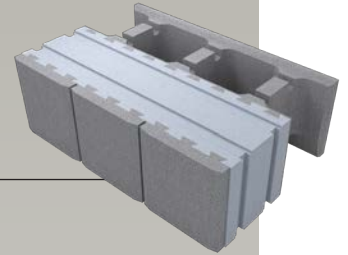

KK4002 partial block
600 x 400 x 200 mm
27 kg

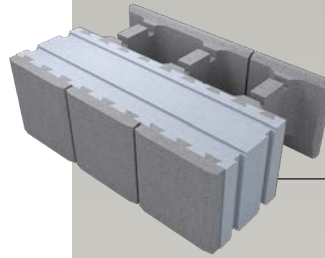

KK400P end block
600 x 400 x 200 mm
27 kg

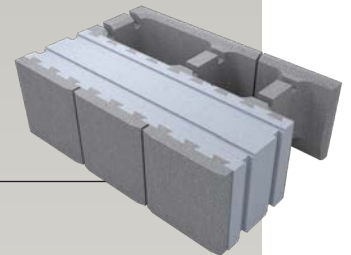

KK400SK inner corner block
600 x 400 x 200 mm
27 kg

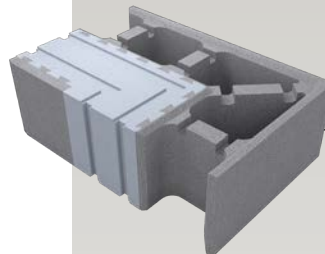

KK400UK outer corner block
600 x 400 x 200 mm
27 kg

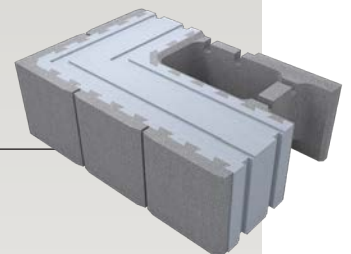

KK400H split block
600 x 200 x 200 mm
7 kg

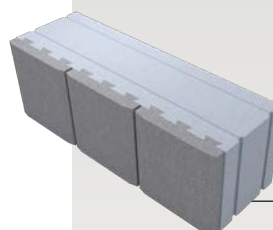

Lammi Tassu foundation mold®

TASSU	Lenght(mm)	Depth(mm)	Height(mm)	kg(pc)
LT24	5000	400	200	16
LT25	5000	500	200	16
LT26	5000	600	200	16,5
LT34	5000	400	300	17
LT36	5000	600	300	19
LT37	5000	700	300	20,5
LT38	5000	800	300	21
LT39	5000	900	300	21,5
LT310	5000	1000	300	22
LT44	5000	400	400	19,5
LT45	5000	500	400	19,5
LT46	5000	600	400	21
LT47	5000	700	400	22
LT48	5000	800	400	22
LT49	5000	900	400	22
LT55	5000	500	500	22
LT56	5000	600	500	22
Pillar mold				
P34	400	400	300	2
P35	500	500	300	2
P36	600	600	300	2,5
P37	700	700	300	3
P38	800	800	300	3
P39	900	900	300	5
P310	1000	1000	300	5
P45	500	500	400	5
P48	800	800	400	5
P56	600	600	500	6
P58	800	800	500	6

Quick and easy

Suitable for year-round construction and manufactured with a patented method, the Lammi Tassu ready-made foundation form is a quick, easy and cost-effective solution for making the foundation of buildings.

The ready-made Tassu foundation mold is light to handle and easy to process, and no special tools or skills are needed for installation. The 5 m long forms with basic reinforcement weigh only 20 kg. With a pre-reinforced mold, the foundation can be completed in just one day.



Normal casting

When the forms are in place, additional reinforcement is installed into them, if necessary. After this, the casting of the molds is performed by concrete pumping. The building of the plinth can be started as soon as the concrete is dry.



Costs under control

Thanks to quick installation and ready-made basic reinforcement, it is easy to estimate the costs. The cast mold does not need to be dismantled. Therefore, no demolition waste is created when using Tassu. The yard remains clean and safe, and no costs arise from the handling of construction and demolition waste either.



Used working time wh/lm = necessary worker-hours per one linear metre of foundation. The working hours used are average working hours measured at a detached house construction site.

wh/lm

0,70
0,60
0,50
0,40
0,30
0,20
0,10
0

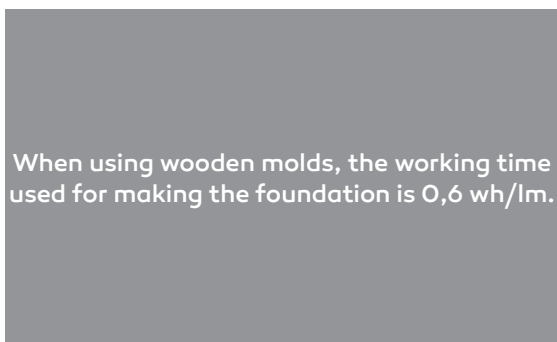

Using wooden molds

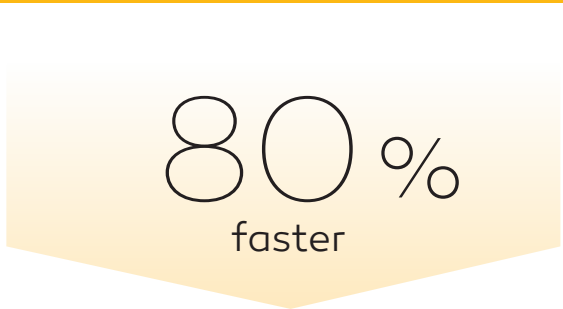

When using Tassu, the working time needed for making the foundation is 0.12 wh/lm.

Using Tassu foundation mold

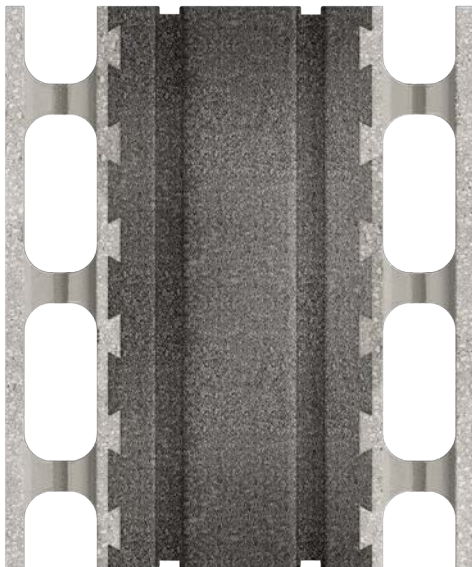

info@lammi.fi / info@lammi.pl

Lammin Betoni Ltd
Paarmamäentie 8
16900 Lammi, Finland

lammi.fi / lammi.pl



LAMMI